

UNIT-III STEPPER MOTOR

Stepper Motor: - It is a form of synchronous motor and is designed to rotate a specified number of degrees for each electrical pulse applied to control winding. The typical steps are 1.5° , 2° , 2.5° , 5° and 7.5° for each pulse.

Stepper motor is designed with multiple phases stator winding and number of poles depends on the required degrees of rotation per pulse. The rotor can be either permanent magnetic type or variable reluctance type. It is also called position control system. The average motor speed is proportional to the rate at which the input command is developed

Types of stepper motor:-

The stepper motor can be divided into three categories-

- Variable Reluctance Stepper Motor.
- Permanent Magnet stepper motor.
- Hybrid stepper motor.

Variable Reluctance Stepper Motor:-

Variable reluctance stepper motor, the number of poles on the stator and rotor are different & gives the motor ability of bi-direction rotation & self-starting capability.

If the number of stator poles are N_r then for a three phase motor, the rotor pole in terms of N_s and q are given by-

$$N_r = N_s + (N_s / q)$$

$$\text{Or } N_r = N_s - (N_s / q)$$

For example for $N_s = 6$ & $q = 3$ then rotor poles are 8, 4 pole.

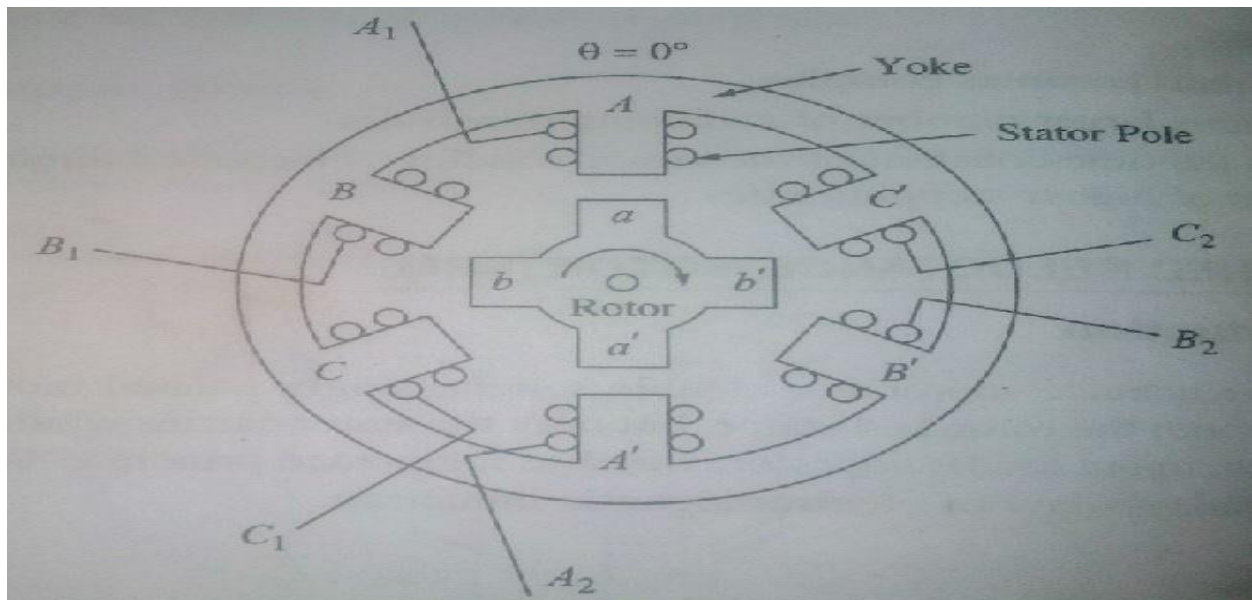

Operation:- The coils wound around diametrically opposite pole are connected in series and the three phases are energized from A.C. source with helps o switches.

The operation is based on various reluctance position of rotor with respect to stator.

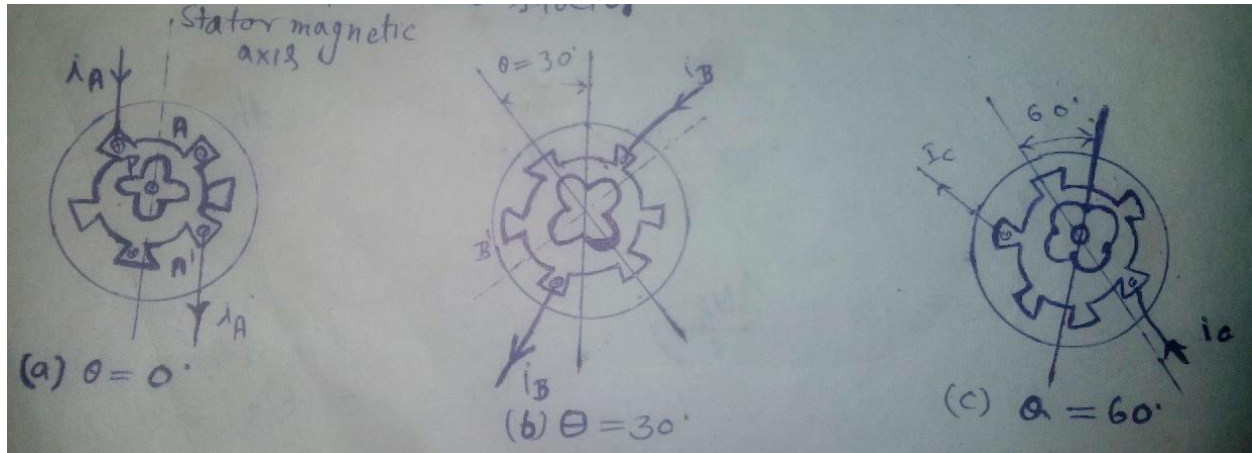

When the phase AA' is excited with the switch SW₁ closed, then stator magnetic axis along the pole formed due to AA'. Then rotor adjusted itself in a minimum reluctance position shown fig (a).

When the phase BB' is excited with the switch SW₂ closed, then stator magnetic axis shift along the poles-formed due to BB' shown above fig (b). Then rotor tries to align in the minimum reluctance position & turns through 30° in anticlockwise direction. So axis passing through two diagonally opposite poles of rotor matches with the stator magnetic axis.

When the phase CC' is excited with SW₃ closed and the phase AA' and BB' are de-energized, then the stator magnetic axis shift along the poles formed due to CC' shown above fig (c). Then rotor achieve minimum reluctance position, rotor gets subjected to further anti clock wise direction.

If I is the current passing through the phase which is excited then the torque developed by the motor which acts on the rotor is expressed as,

$$T_m = \frac{1}{2} i^2 \frac{dL}{d\theta}$$

Observation:- Form the above discussion , the following observation can be made-

- The rotor can be moved in a specific direction, by exciting the stator phases in a specific sequence.
- When the phases are excited in the sequence A-B-C-A the rotor move in the anti-clock wise direction.
- When the phase are excited in the sequence C-B-A-C the rotor moves in the clock wise direction, which can be easily verified.

- The distance through which the rotor moves when all three phase are excited once is called one rotor tooth.

$$\text{Rotor Tooth Pitch} = \frac{360}{N_r}$$

- The slip angle is denoted as $\alpha_s = 360 / q N_r$
So for three phase and four rotor pole the step angle is

$$\alpha_s = \frac{360}{3 \times 4} = 30^\circ$$

Micro stepping:- If the two phase are excited simultaneously. i.e. keeping AA' excited, the BB' is also excited with SW₁ & SW₂ closed, then the stator magnetic axis shift to a mid-position rather than along BB'. Hence rotor gets aligned along this move through a half step. i.e. 15°

A logical extension of this technique is to control current in the windings so that several stable equilibrium positions are created. Normally the step angle is reduced by factor of are created. Normally the step angle is reduced by factor of $\frac{1}{2}$, $\frac{1}{5}$, $\frac{1}{10}$, $\frac{1}{16}$ or $\frac{1}{32}$. This technique is called micro stepping.

A further reduction in step angle can be achieved by increasing the number of poles at the stator and rotor by adopting different construction such as-

- Using reductions gear mechanism.
- Using multi stack arrangement.

Multi Stack Stepper Motor: - These are used to obtain small size typically ranging b/w 2 to 15.

In a m stack motor is divided in to a m number of magnetically isolated section called stacks. The stator has a common frame while the rotors are mounted on a common shaft. The stator and rotors have same number of pole (teeth). The stator poles in all m stacks aligned while the rotor poles are shifted by (1/ m) of the pole pitch generally three stepper motor used.

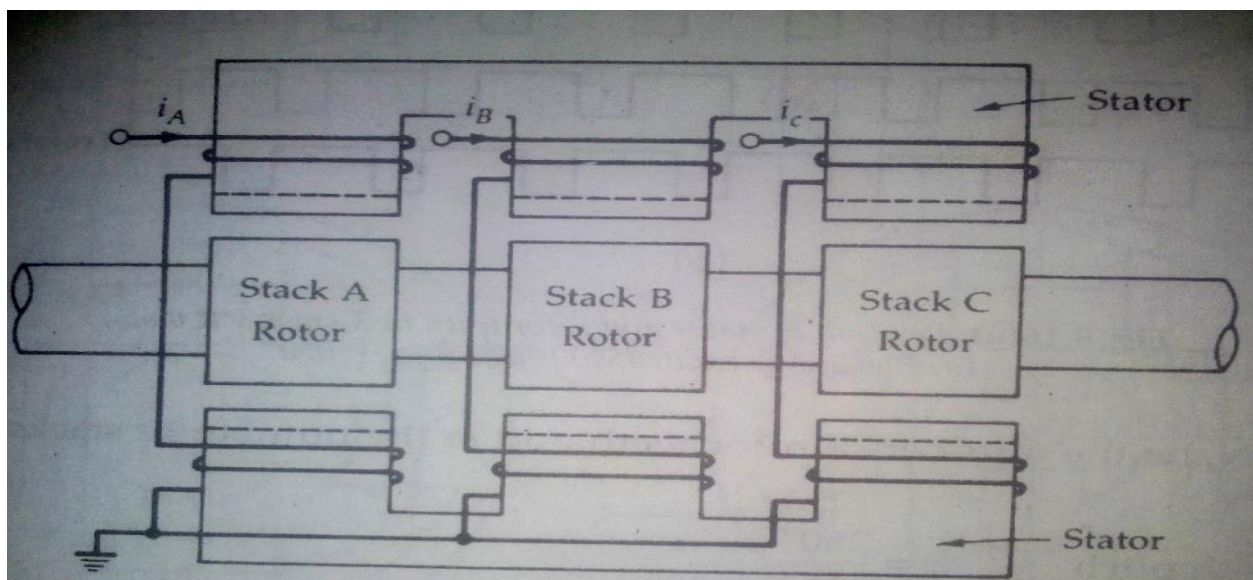

The above fig. had shown the cross-section view of a three stack. There phase variable reluctance motor. The various winding in one stacks are energized simultaneously. when A of stator is excited then rotor poles of stack A get aligned with the stator poles. But due to offset, rotor poles as stacks B & C do not align. Now if phase B get aligned with stator pole. Thus moves by one third of pole pitch. When B is de-energized and C excited rotor pole of stack C get aligned with the stator poles.

If m is the number of stacks i.e. phase Nr be the rotor then the step angle is given by-

$$\alpha_s = \frac{360}{mNr}$$

Reduction gear stepper motor:-

The above fig shown reduction gear stepper motor. The stator has 8 salient poles and four phases for used as exciting winding. The rotor has 18 teeth & 18 slots uniformly distributed around. Each salient pole of the stator consist of two teeth , forming an interleaving slot of the same angular periphery as the rotor teeth or slot.

The step angle reduces to 5° by successive excitation of coils A-A' , B-B' C-C' and D-D', the rotor makes 72 step angle α_s , number of stator phases q and rotor poles or teeth Nr remain same as.

$$\alpha_s = \frac{360}{qNr}$$

Advantages of variable Reluctance Motor:- The variable reluctance stepper motor has following advantages-

- High torque to inertia ratio.
- High rated of acceleration.
- Fast dynamic response.
- Simple & low cost machine.
- Efficient cooling arrangements as all winding are on stator and there is no winding on rotor.
- Rotor construction is robust due to absence of brushes.

Permanent magnet stepper motor:-

The stator of this type multipolar, the stator has four pole . Around the pole the exciting coils are wound. The number of slot per pole per phase is usually chosen as one in such multipolar machines. The rotor may be salient or smooth cylindrical. it is out of ferrite material . Due to this motor is called permanent magnet stepper motor.

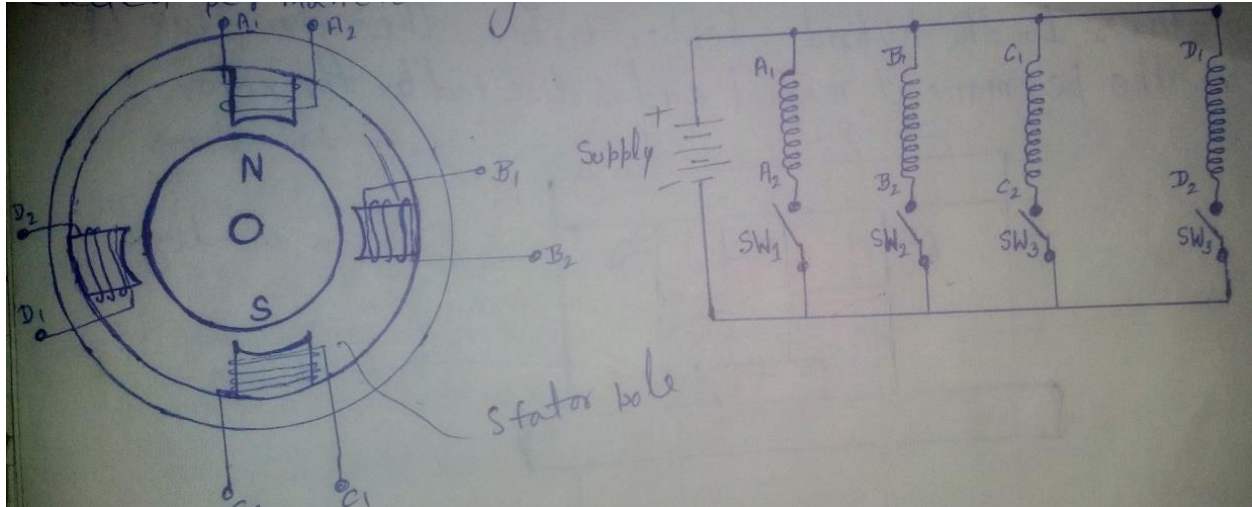

Operation:- The voltage pulses are applied to various phases with the help of driven circuit , a rotor starts rotating through a step for each input voltage pulse.

When SW_1 is closed exciting the phase A. Due to its excitation, we have N pole is phase A. Due to the electromechanical torque developed, rotor rotates such that magnetic axis of permanent magnet rotor adjust with the magnet axis of the stator.

The B_1B_2 phase is excited with the switch SW_2 . due to this , rotor further adjust its own magnetic axis with N pole of phase B. Hence it rotates through 90° further in anti-clock wise direction.

Similarly when phase C & D are sequently excited the rotor tends to rotate through 90° in clock wise direction, every time when phase is excited.

The stepper motors with permanent magnet rotors with large number of poles can not be manufactured in small size. Hence small step are not possible . This is biggest disadvantages of permanent magnet stepper motor.

Hybrid stepper motor:-

The hybrid stepper motor used the principle of the permanent magnet & variable reluctance stepper motors. In hybrid stepper motor, the rotor flux is produced by the permanent magnet and is directed by the rotor.

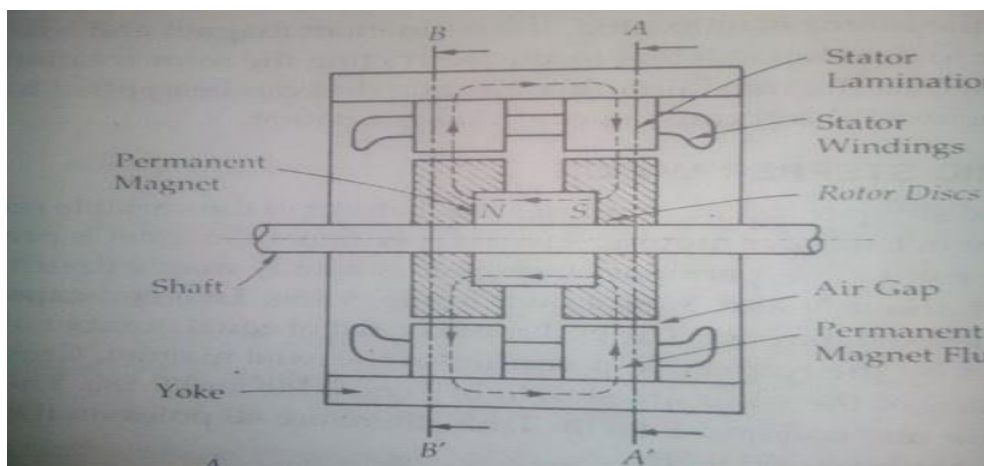

The permanent magnet is placed in the middle of the rotor. It magnetized in the axial direction. The main flux path is form the north pole of the magnet , in to the end stack , across the air gap through the stator pole , axially along the stator , through the stator pole , across the air gap and back to the magnet south pole.

There are usually 8 pole on the stator. Each pole has between 2 to 6 teeth . there is two phase winding. The coils on poles 2, 4, 6 and 8 are connected in series to form phase B. the winding A & B are energized alternatively.

When phase A carries positive current, stator poles 1 to 5 become south and 3 & 7 become north. The rotor teeth with north & south polarity align with the teeth of stator poles 1 & 5 and 3 & 7 respectively.

The torque in a hybrid motor is produced by the interaction of the rotor and the stator produced fluxes. The rotor filed remains constant. The motor torque T_m is proportional to the phase current.

Following are the main advantages of the hybrid stepper motor-

- Vary small step angle up to 1.8°
- Higher torque per unit volume which is more than in case of variable reluctance motor.
- Due to permanent magnet , the motor has some detent torque which is absence in variable reluctance motor.

Characteristics of Stepper motor:-

The stepper motor characteristics are classified as-

- Static characteristics
- Dynamic characteristics

Static characteristics:-These characteristics include –

- Torque – Displacement characteristics.
- Torque – current characteristics

Torque-Displacement characteristics:- this gives the relationship between electrodynamic torque developed and displacement angle θ from steady state position. The characteristics shown below fig.

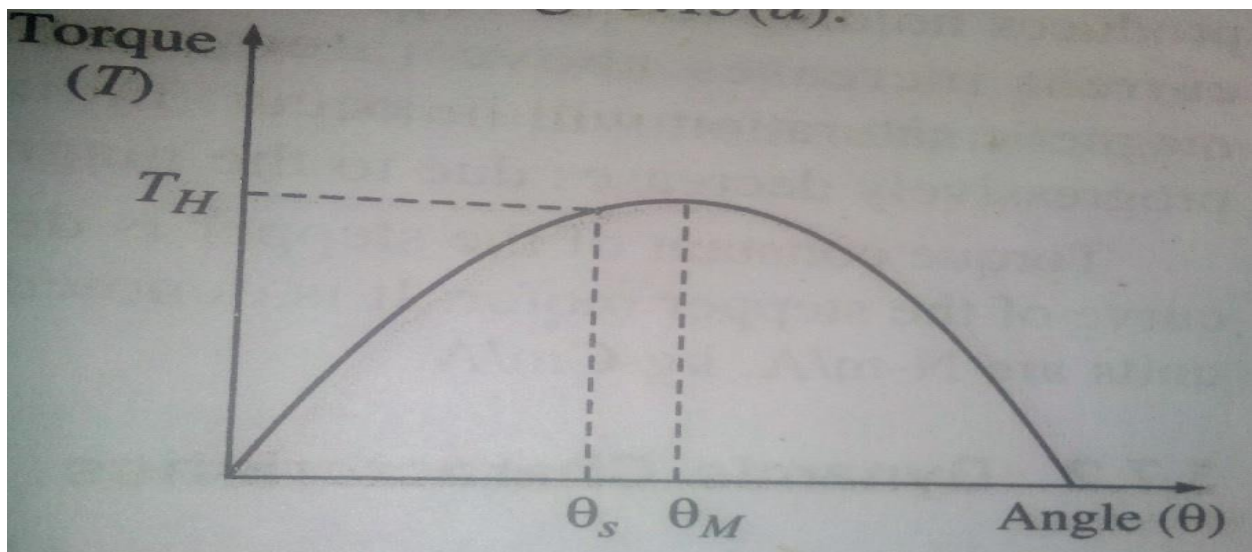

Torque-current characteristics:- The holding torque of the stepper motor increases with the exciting current . The relationship between the holding torque and current is called as torque-current characteristics. These characteristics shown below.

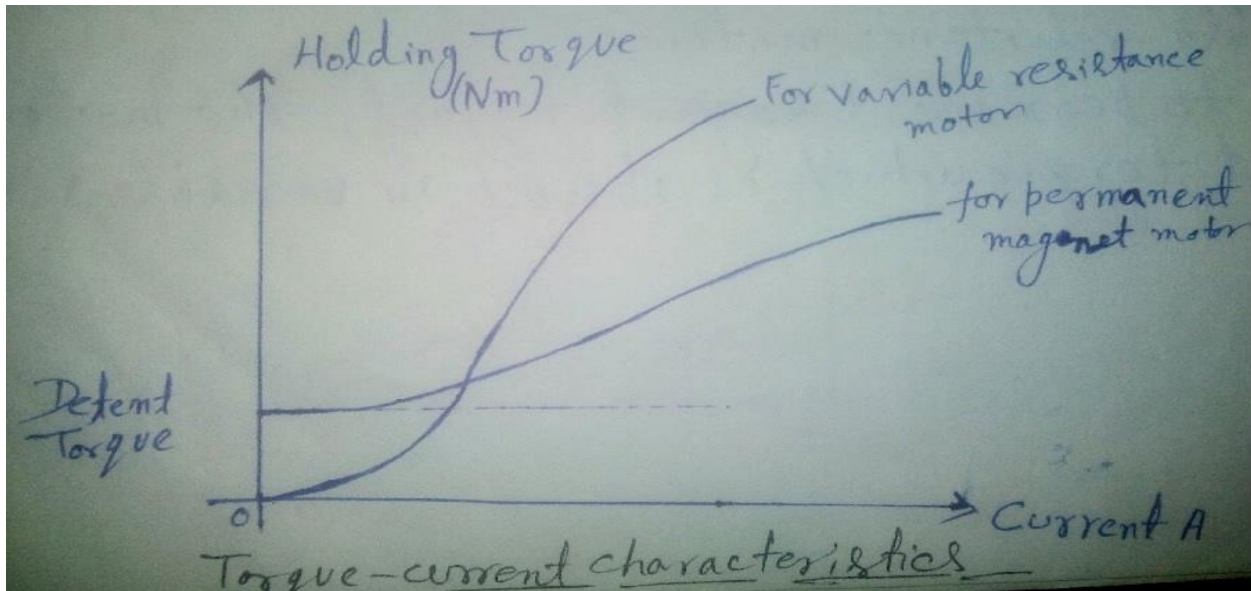

Dynamics Characteristics :- The dynamics characteristics gives the information regarding torque stepping rate . There are also called torque stepping rate curve of the stepper motor. These are shown below-

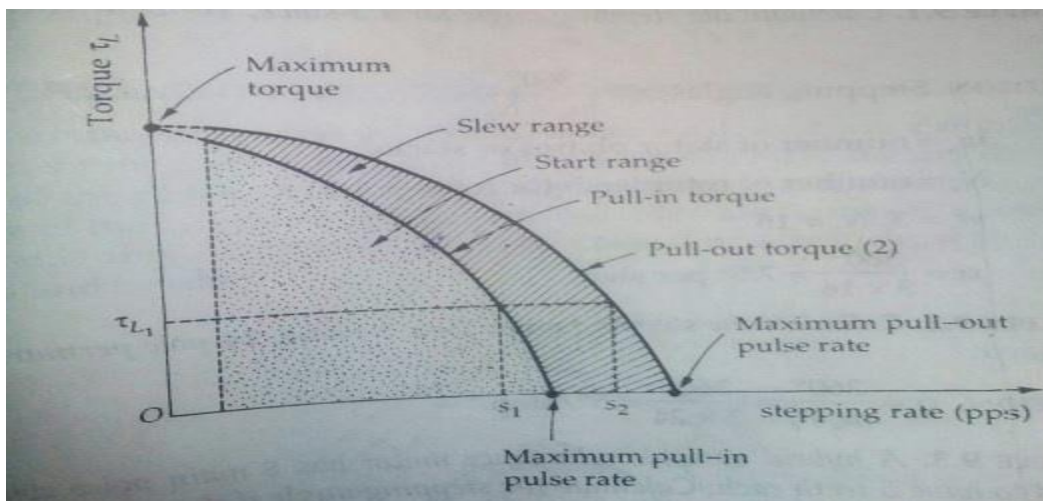

When stepping rate increases, rotor gets less time to drive the load from one position to other. Now if the value of load torque and stepping rate are such that point of operation lies to the left of curve I. then motor can start and synchronized without missing a pulse . once motor has started and synchronized , then stepping rate can be increased . such an increase in the stepping rate f_1 to f_2 is with out missing the synchronism . but beyond f_2 , if stepping rate is increased motor will loose its synchronism.

Thus area between the curve I & II indicates, for various torque values the ranges of stepping rate which the motor can follow without missing step, provided that the motor is started and synchronized. This area of operation of the stepper motor is called slew range. The motor is said to be operating in slewing mode.

Thus slew range is important for speed control application.

Application of stepper motor:- they are widely used in computer peripherals such as serial printers, linear stepper motor to printer, tape drive, floppy disc drive etc. Stepper motors are also used in serial printers in type writer or word processor systems, numerical control of machine tools, robotic control system, number of process control system, actuators spacecraft's watches etc.

Drive Circuit for stepper Motors:- A stepper motor is usually driven from a low voltage dc source. The dc source is connected to the phase by a semiconductor switch S. When the phase is to be de-energized, switch is turned off, which transfers the current to freewheeling diode D_F . Motor torque, which is a function of I_{ph} , builds up and decays in the same manner. In order to maximize torque capability of a step motor, drive should be such that current builds up & decay as fast as possible.

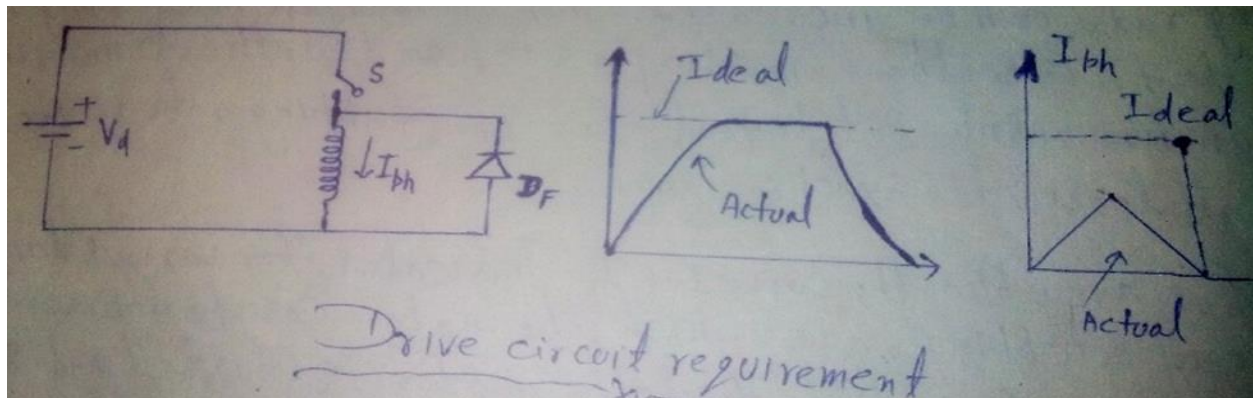

Unipolar Drive for variable Reluctance motor:- variable reluctance motors, phase currents need only be switched ON or OFF. A simple unipolar drive circuit suitable for low power two phase reluctance motor.

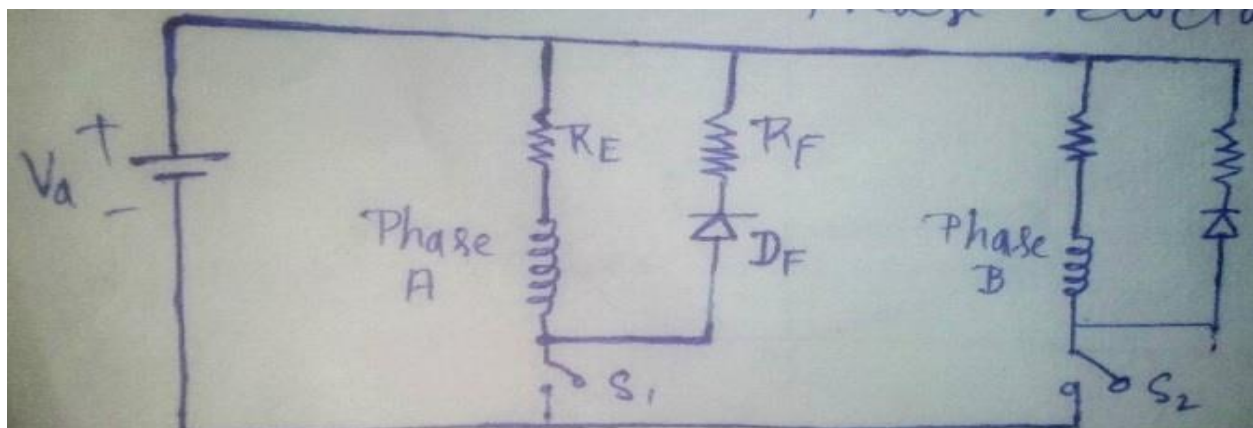

When switch S_1 is closed, phase A winding is connected to the dc source V_d and the phase current decays in the freewheeling path consisting of phase A D_F and R_F . The voltage source V_d is chosen to produce the rated current I_R in the phase winding. Thus

$$V_d = I_R (R_E + R_P)$$

The unipolar circuit is highly efficient and therefore is suitable only for low power stepper 3

Bipolar drive permanent magnet and hybrid motors:- A simple bipolar drive circuit for one phase shown below. The phase winding carries a positive current when semiconductor switches S_1 and S_2 conduct and it carries a negative current when switch S_3 & S_4 conduct.

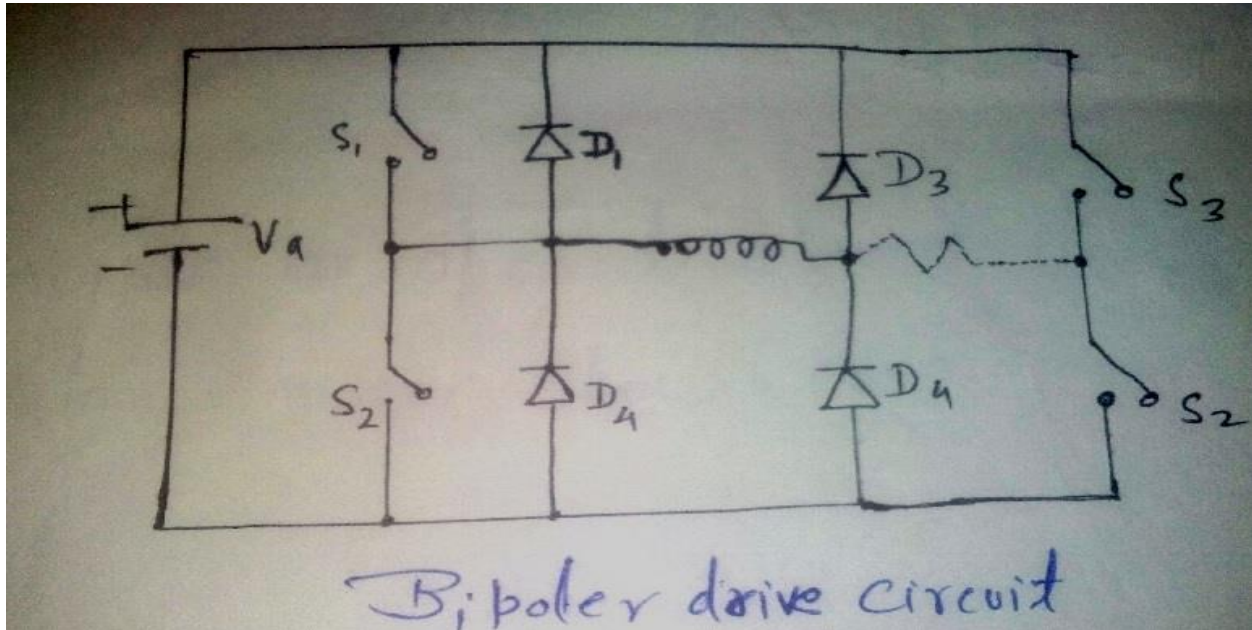

The phase winding is energized with positive when S_1 & S_2 are turned ON. The external resistance R_E reduces the electrical time constant allowing rapid buildup of phase current. The phase is de-energized by turning off S_1 & S_2 winding current now flows through the path consisting of D_3 , source V_d & D_4 . The major proportion of energy stored in phase winding inductance is feedback to the source and phase current decays rapidly to zero.

Switch Reluctance motor :- The switch reluctance motor (SRM) has both salient pole stator and rotor like variable reluctance stepper motor. A switch reluctance motor is used in variable speed drives and is naturally designed to operate efficiently for a wide range of speed and torque and requires rotor position sensing. Switched reluctance motor is quite different from the synchronous reluctance motor. They have two major differences.

The synchronous reluctance motor has a cylindrical stator with distributed winding, the switch reluctance motor stator has salient pole stator with concentrated coils.

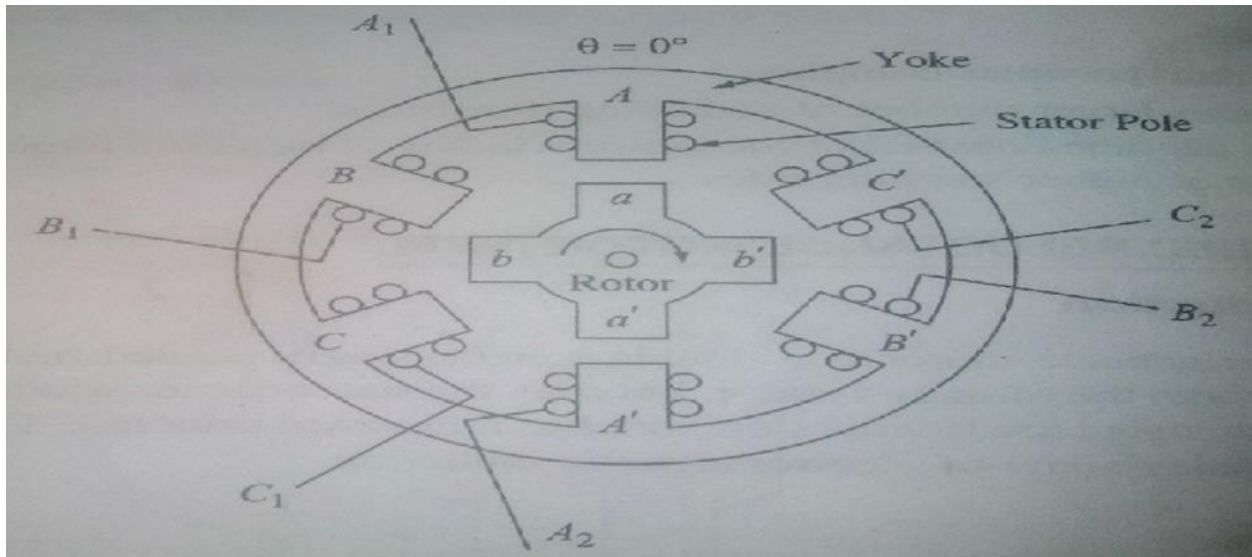

Principle of operation:- A four Pole , 8/6 pole switch reluctance motor show below-

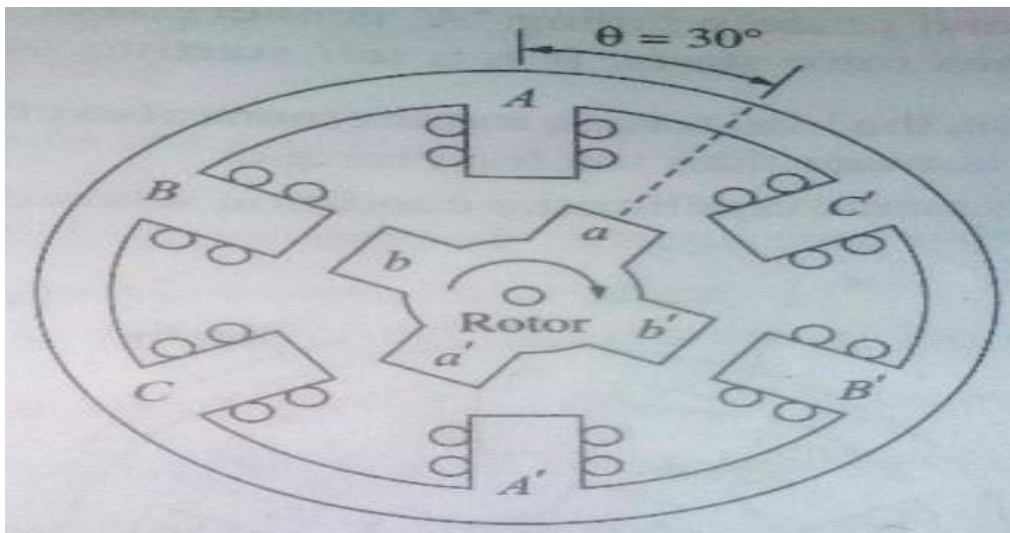

When a stator phase is excited, the reluctance torque make the motor to move to word the position of minimum reluctance. As the rotor reaches the position of minimum reluctance a, excitation is shifted to next phase thus shifting the position of minimum reluctance is continuously shifted by shifting excitation from one phase to another and the reluctance torque make the rotor to continuously move . The direction of rotation can be changed by exciting the phase in the reverse sequence.

The inductance of a stator phase winding is a function of rotor position due to the saliency of stator and rotor. In the fully aligned position , the phase winding inductance is maximum and the reluctance of the magnetic circuit is minimum.

Torque Production:- Consider the phase winding excited by a voltage source, of voltage V. then-

$$V = Ri + \frac{d\phi}{dt}$$

substituting $\phi = Li$

$$V = Ri + \frac{dLi}{dt}$$

$$V = Ri + L \frac{di}{dt} + i \frac{dL}{dt}$$

$$V = Ri + L \frac{di}{dt} + i \left[\frac{dL}{d\theta} \right] \left[\frac{d\theta}{dt} \right]$$

$$V = Ri + L \frac{di}{dt} + \omega_m i \left[\frac{dL}{d\theta} \right]$$

The term $\omega_m i \left[\frac{dL}{d\theta} \right]$ is the phase winding back emf e given by following equation –

$$E = \omega_m i \frac{dL}{d\theta}$$

The back emf function of I , ω_m and $\left[\frac{dL}{d\theta} \right]$.

The instantaneous electrical power i/p to the machine is given

$$Vi = Ri^2 + Li \frac{di}{dt} + \omega_m i^2 \left[\frac{dL}{d\theta} \right]$$

$$Vi = Ri^2 + \left[Li \frac{di}{dt} + \frac{1}{2} \omega_m i^2 \left[\frac{dL}{d\theta} \right] \right] + \frac{1}{2} \omega_m i^2 \left[\frac{dL}{d\theta} \right]$$

$$Vi = Ri^2 + \frac{di}{dt} \frac{1}{2} Li^2 + \frac{i^2}{2} \left[\frac{dL}{d\theta} \right] \omega_m$$

$$Vi = Ri^2 + \frac{di}{dt} \frac{1}{2} Li^2 + \frac{i^2}{2} \left[\frac{dL}{d\theta} \right] T_m$$

Where T is the instantaneous value of developed torque.

The instantaneous power supplied to the machine VI is utilized to provide the following-

- Winding heat losses i^2R .
- Rate of change of the speed control magnitude field energy is $\frac{di}{dt} \frac{1}{2} Li^2$.
- The mechanical power output, the motor torque is given by $T = \frac{i^2}{2} \left[\frac{dL}{d\theta} \right]$.